



Cambridge International AS & A Level

BIOLOGY

9700/12

Paper 1 Multiple Choice

May/June 2021

1 hour

You must answer on the multiple choice answer sheet.

You will need: Multiple choice answer sheet
Soft clean eraser
Soft pencil (type B or HB is recommended)

INSTRUCTIONS

- There are **forty** questions on this paper. Answer **all** questions.
- For each question there are four possible answers **A, B, C** and **D**. Choose the **one** you consider correct and record your choice in soft pencil on the multiple choice answer sheet.
- Follow the instructions on the multiple choice answer sheet.
- Write in soft pencil.
- Write your name, centre number and candidate number on the multiple choice answer sheet in the spaces provided unless this has been done for you.
- Do **not** use correction fluid.
- Do **not** write on any bar codes.
- You may use a calculator.

INFORMATION

- The total mark for this paper is 40.
- Each correct answer will score one mark.
- Any rough working should be done on this question paper.

This document has **16** pages. Any blank pages are indicated.



1 Which row describes the membranes surrounding each cell structure?

	chloroplast	mitochondrion	nucleus
A	single	single	double
B	double	single	single
C	single	double	single
D	double	double	double

2 The mean width of mitochondria in an electron micrograph is 6 mm.

The magnification of the electron micrograph is $\times 9600$.

What is the actual mean width of the mitochondria?

- A** 6×10^{-3} mm **B** 6×10^{-4} mm **C** 6×10^{-2} μm **D** 6×10^3 μm

3 Which sequence shows the correct order of some of the stages in the production and secretion of an enzyme?

- A** Golgi body \rightarrow ribosome \rightarrow rough endoplasmic reticulum \rightarrow mRNA
B mRNA \rightarrow smooth endoplasmic reticulum \rightarrow Golgi body \rightarrow vesicle
C ribosome \rightarrow rough endoplasmic reticulum \rightarrow vesicle \rightarrow Golgi body
D smooth endoplasmic reticulum \rightarrow mRNA \rightarrow vesicle \rightarrow ribosome

4 Different antibiotics function in different ways. Ideally, the antibiotic kills the bacteria, but does not harm the infected human.

One type of antibiotic, tetracycline, can affect the way in which human mitochondria function.

What explains the effect of tetracycline on human mitochondria?

- 1 The antibiotic prevents the synthesis of peptidoglycan cell walls.
- 2 The antibiotic prevents synthesis of linear DNA.
- 3 The antibiotic prevents translation by binding to 70S ribosomes.

- A** 1 and 2 **B** 2 and 3 **C** 2 only **D** 3 only

5 A prokaryotic cell is $5.0\ \mu\text{m}$ in length.

A virus particle is 300 nm in length.

How many times larger is the prokaryotic cell compared to the virus particle?

- A** 2 **B** 17 **C** 60 **D** 167

6 A student carries out a semi-quantitative test with Benedict's solution.

Which statement about this procedure is correct?

- A** It detects only the presence or absence of glucose.
B It provides an indication of relative reducing sugar concentrations.
C The precipitate needs to be filtered, dried and weighed to give the reducing sugar concentration.
D A colorimeter needs to be used to determine the glucose concentration.

7 Which row is correct for carbohydrates?

	macromolecule	monomer	polymer
A	sucrose	starch	α -glucose
B	glycogen	sucrose	starch
C	α -glucose	glycogen	sucrose
D	starch	α -glucose	glycogen

8 Which shows the correct general formula for glycogen?

- A** $(\text{C}_5\text{H}_{10}\text{O}_5)_n$ **B** $(\text{C}_5\text{H}_{10}\text{O}_6)_n$ **C** $(\text{C}_6\text{H}_{10}\text{O}_5)_n$ **D** $(\text{C}_6\text{H}_{12}\text{O}_6)_n$

9 Chitin is a structural polysaccharide found in the hard, outer shells of animals such as crabs.

Chitin is made of chains of amino sugars that contain NH groups.

The diagram shows two sugars in the chain of a chitin molecule.

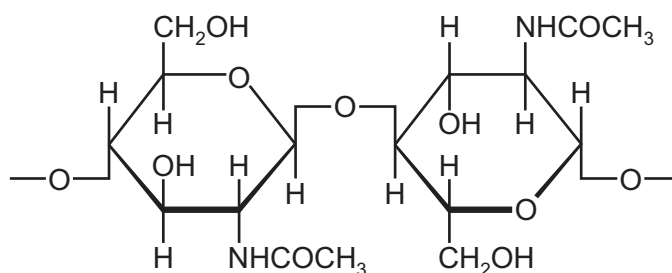

Which polysaccharide is most like chitin?

- A amylopectin
- B amylose
- C cellulose
- D glycogen

10 Four fatty acids and their formulae are listed.

caprylic acid	$\text{CH}_3(\text{CH}_2)_6\text{COOH}$
lauric acid	$\text{CH}_3(\text{CH}_2)_{10}\text{COOH}$
oleic acid	$\text{CH}_3(\text{CH}_2)_7\text{CH}=\text{CH}(\text{CH}_2)_7\text{COOH}$
palmitoleic acid	$\text{CH}_3(\text{CH}_2)_5\text{CH}=\text{CH}(\text{CH}_2)_7\text{COOH}$

Which fatty acids are saturated?

- A caprylic acid and lauric acid
- B caprylic acid and oleic acid
- C lauric acid and palmitoleic acid
- D oleic acid and palmitoleic acid

11 Which molecule contains the smallest number of hydrogen atoms?

- A α -glucose
- B glycine, an amino acid in which the R group is H
- C glycerol
- D a saturated fatty acid containing eight carbon atoms

12 The diagram shows sucrose and sucralose.

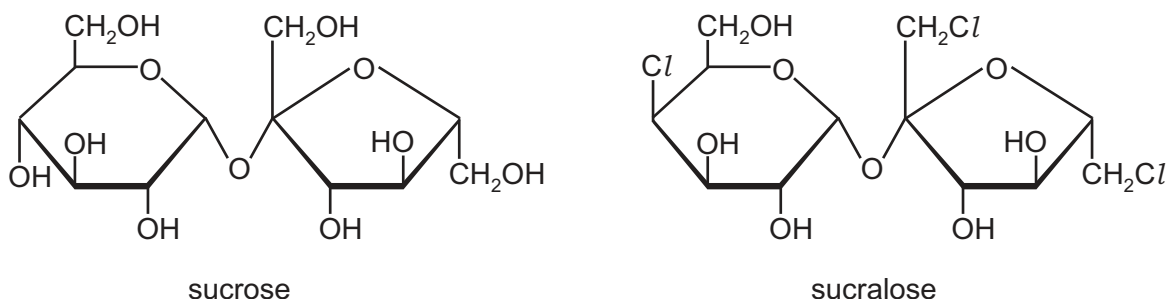

The enzyme sucrase breaks down sucrose but cannot break down sucralose. Four students were asked to suggest why sucrase can break down sucrose but not sucralose.

Three of the students gave correct suggestions.

Which suggestion **cannot** be correct?

- A The Cl atoms change the shape of the sucralose molecule so it is not the same shape as the active site of sucrase.
 - B The Cl atoms of the modified fructose cannot bind to the active site of sucrase.
 - C The Cl atoms cannot cause an induced fit, so sucralose does not enter the active site of sucrase.
 - D The Cl atoms cause fewer temporary hydrogen bonds between sucralose and the active site of sucrase.
- 13 The graph shows the energy levels involved in an enzyme-catalysed reaction. Substrate molecules X and Y combine to give product Z.

Which arrow shows the reduction in activation energy due to the enzyme?

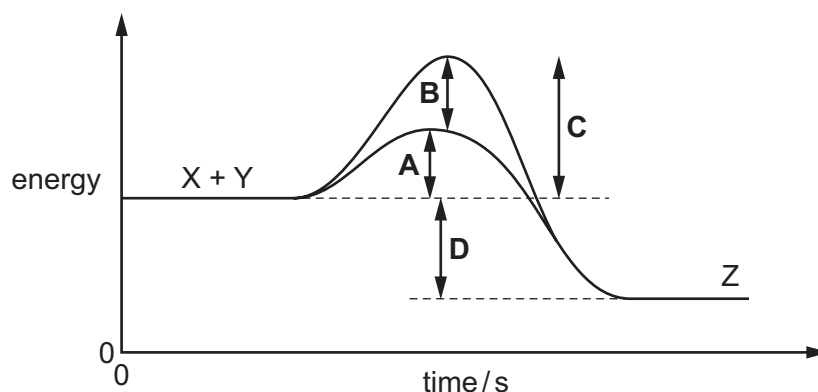

14 Which roles of the cell surface membrane result from the properties of the phospholipids?

- 1 to allow cytokinesis to occur in mitotic cell division
- 2 to allow entry and exit of oxygen and carbon dioxide
- 3 to allow the phagocytosis of a bacterium into a cell

A 1, 2 and 3 **B** 1 and 2 only **C** 1 and 3 only **D** 2 and 3 only

15 Which factors can be changed to affect the rate of facilitated diffusion across a cell surface membrane?

- 1 the surface area of the membrane
- 2 the concentration gradient
- 3 the number of specific protein channels

A 1, 2 and 3 **B** 1 and 2 only **C** 1 and 3 only **D** 3 only

16 The diagram shows an experiment using a model cell to investigate the movement of substances.

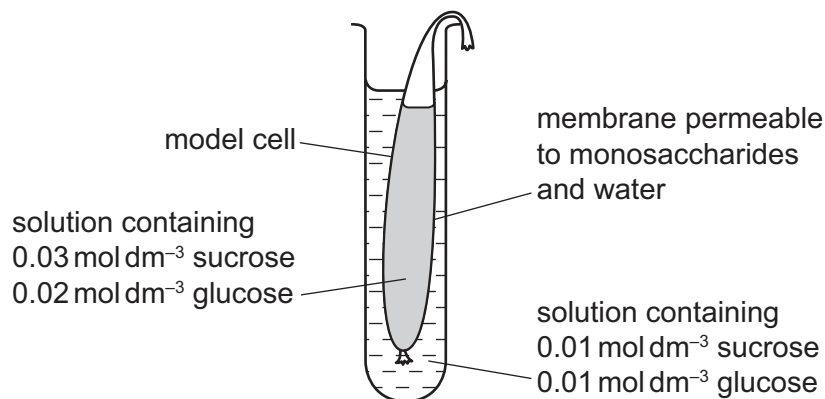

Which statements are correct?

- 1 There is net movement of sucrose out of the model cell.
- 2 There is net movement of glucose out of the model cell.
- 3 There is net movement of water into the model cell.

A 1, 2 and 3 **B** 1 and 2 only **C** 1 and 3 only **D** 2 and 3 only

- 17 Human chromosomes have different parts. Some parts are more numerous than others.

Which parts are listed in order from **most** numerous to **least** numerous in a human white blood cell?

- A** centromere → nucleotide → histone protein
B DNA molecule → telomere → centromere
C histone protein → telomere → DNA molecule
D telomere → centromere → nucleotide

- 18 The diagram represents the cell cycle of a human cell. During the cell cycle the number of chromatids changes.

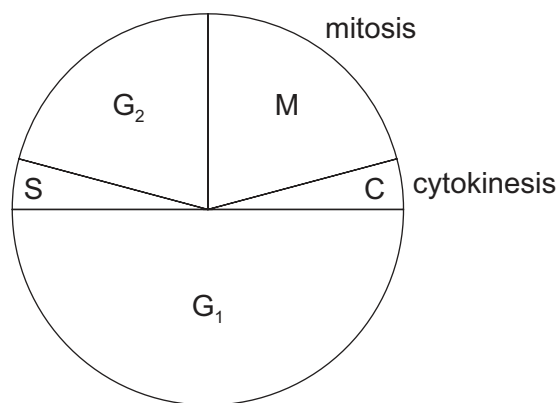

Which row is correct for the number of chromatids in M, G₁, and G₂?

	M	G ₁	G ₂
A	46	46	92
B	46	92	92
C	92	46	92
D	92	92	92

- 19 A single skin cell was isolated and transferred to growth medium in a sterile Petri dish. The Petri dish was incubated for 16 days. During this time, the number of skin cells multiplied as a result of repeated mitotic divisions.

One of the chromosomes in the nucleus of each skin cell has a telomere that contains many repeats of the base sequence TTAGGG. On each of days 4, 8, 12 and 16 of the incubation period, a single cell was removed from the Petri dish. The total number of bases in the telomere of this chromosome was determined for each cell. Each of the four cells had a different total number of telomere bases for this chromosome: 5548, 5580, 5645 and 5700.

What was the total number of telomere bases in the chromosome from the cell that had undergone the most mitotic divisions?

- A** 5548 **B** 5580 **C** 5645 **D** 5700

- 20 A short piece of DNA, 18 base pairs long, was analysed to find the number of nucleotide bases in each of the polynucleotide strands.

Some of the results are shown in the table.

	number of nucleotide bases			
	adenine	cytosine	guanine	thymine
strand 1		4		7
strand 2		5		

How many nucleotides containing thymine were present in strand 2?

- A** 2 **B** 4 **C** 5 **D** 7

- 21 The diagram shows a strand of DNA and mRNA during transcription.

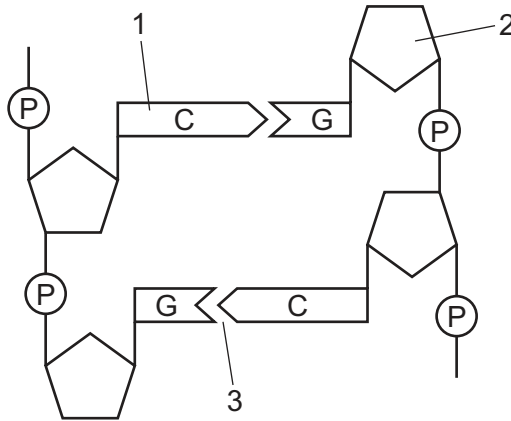

Which row correctly identifies 1, 2 and 3?

	1	2	3
A	purine	deoxyribose	two hydrogen bonds
B	purine	ribose	three hydrogen bonds
C	pyrimidine	deoxyribose	two hydrogen bonds
D	pyrimidine	ribose	three hydrogen bonds

22 Two students were discussing the involvement of DNA and RNA in transcription and translation.

- Student 1 always stated correct facts.
- Student 2 gave further information, which was sometimes correct.

	correct facts given by student 1	further information given by student 2
1	A length of mRNA is 747 nucleotides long, including stop and start codons.	This mRNA can produce a polypeptide that is 249 amino acids long.
2	Adjacent mRNA codons of AAU and CUG bind to complementary tRNA anticodons.	There is a total of 14 hydrogen bonds formed between these two codons and their anticodons.
3	RNA polymerase catalyses the formation of the mRNA from the template strand of DNA.	During translation, an RNA adenine nucleotide will pair with a DNA thymine nucleotide.
4	A DNA adenine nucleotide is structurally different to an RNA adenine nucleotide.	The difference is in the hexose sugars; DNA is deoxyribose and RNA is ribose.

Which further information, given by student 2, is correct?

- A** 1 and 4 **B** 2 and 3 **C** 2 only **D** 4 only

23 Which descriptions of the adaptations of xylem vessel elements to their function are correct?

- 1 They have pits between vessels allowing water to pass from one vessel to another.
- 2 They are thickened with lignin to stop them collapsing when the column of water is under tension.
- 3 They form a continuous hollow tube through the plant providing little resistance to water movement.

- A** 1, 2 and 3 **B** 1 and 3 only **C** 2 only **D** 2 and 3 only

24 The diameter of a tree trunk usually decreases slightly during the day.

Which changes in environmental factors during the day could cause the diameter to decrease even more?

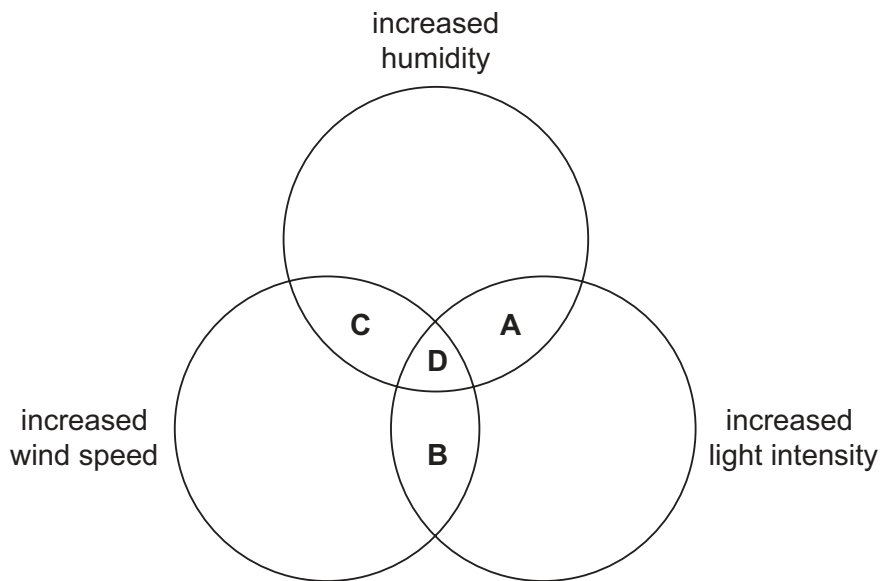

25 A student wanted to find out the rate of transpiration using a potometer as shown.

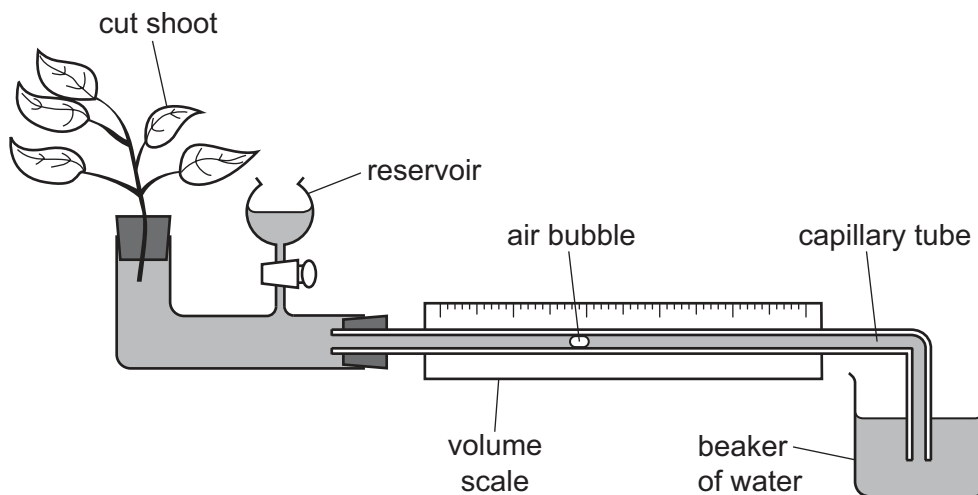

The student was told to work out a value for transpiration using the units mm^3 , m^{-2} and hour^{-1} .

Which measurements would the student need to take?

- A volume of water in the reservoir, length of the capillary tubing, temperature and how many leaves are on the shoot
- B volume of water in the reservoir, radius of the capillary tubing, time and surface area of the leaves
- C distance air bubble moves, radius of the capillary tubing, time and surface area of the leaves
- D distance air bubble moves, length of the capillary tubing, temperature and how many leaves are on the shoot

- 26** In plants, assimilates such as sucrose are loaded from source cells into sieve tube elements. The assimilates are then transported from source to sink.

What is needed to transport sucrose from source cells through phloem tissue to sink cells?

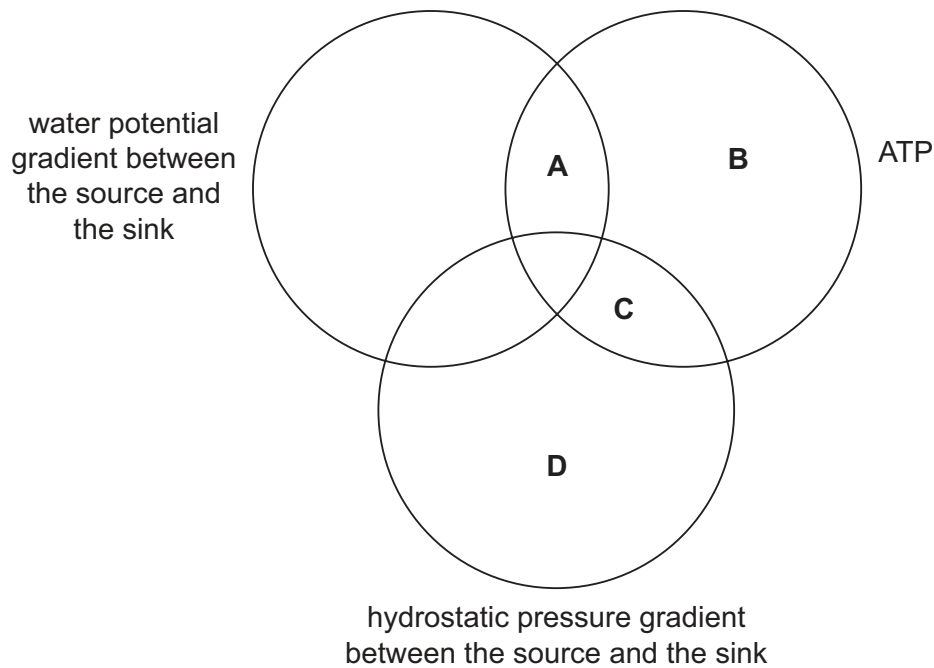

- 27** The sinoatrial node initiates the cardiac cycle.

What is the correct order in which the chambers of the heart contract?

- A** atria and ventricles at the same time
- B** both atria then both ventricles
- C** left atrium, then left ventricle, then right atrium, then right ventricle
- D** right atrium, then right ventricle, then left atrium, then left ventricle

- 28 The graph shows pressure changes in different parts of the heart during a mammalian cardiac cycle. W, X, Y and Z indicate when a valve opens or closes.

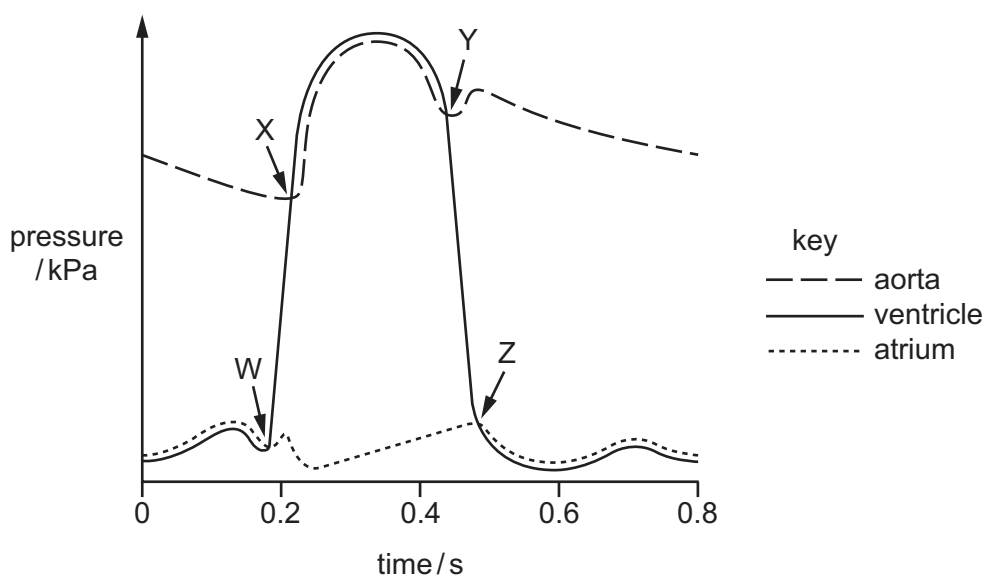

Which row is correct?

	W	X	Y	Z
A	opens	closes	closes	opens
B	opens	opens	closes	opens
C	closes	opens	closes	opens
D	closes	closes	opens	opens

- 29 What can combine with the haem group of a haemoglobin molecule?

- 1 oxygen
- 2 carbon dioxide
- 3 carbon monoxide

- A** 1, 2 and 3 **B** 1 and 3 only **C** 1 only **D** 2 and 3 only

- 30 What is the main reaction occurring in blood capillaries at the gas exchange surface in a human lung?

- A** Carbonic acid dissociates into carbon dioxide and hydrogen ions.
B Carbonic anhydrase converts carbon dioxide into hydrogencarbonate ions.
C Carbon dioxide combines with haemoglobin to form carbaminohaemoglobin.
D Carbon dioxide is produced from hydrogencarbonate ions by carbonic anhydrase.

31 Which reactions take place in blood that is passing through active tissues?

- 1 $\text{HbO}_8 \rightarrow \text{Hb} + 4\text{O}_2$
- 2 $\text{HbO}_8 + \text{H}^+ \rightarrow \text{HHb} + 4\text{O}_2$
- 3 $\text{HCO}_3^- + \text{H}^+ \rightarrow \text{H}_2\text{CO}_3$
- 4 $\text{H}_2\text{O} + \text{CO}_2 \rightarrow \text{H}_2\text{CO}_3$

- A** 1, 2, 3 and 4
B 1, 2 and 4 only
C 1, 3 and 4 only
D 2 and 3 only

32 Which row shows the tissues that are present in the wall of the trachea **and** in the wall of the bronchus?

	cartilage	squamous epithelium	goblet cells	
A	✓	✓	✓	key ✓ = present x = not present
B	✓	✓	x	
C	✓	x	✓	
D	x	✓	x	

33 In some cases where a person has lung disease, the partial pressure of oxygen in the pulmonary veins is less than the partial pressure of oxygen in the alveoli.

What could explain the difference in partial pressure of oxygen?

- 1 A high proportion of alveoli are collapsed and do not have enough alveolar capillaries.
- 2 The partial pressure of oxygen in the pulmonary arteries is lower than in the alveolar air.
- 3 The rate of diffusion of oxygen from the alveolar air to the surrounding alveolar capillaries is too slow.

- A** 1, 2 and 3 **B** 1 and 2 only **C** 1 and 3 only **D** 2 and 3 only

34 How many times must a molecule of carbon dioxide pass through a cell surface membrane as it diffuses from the plasma, through a cell in the capillary wall, into an alveolus?

- A** 1 **B** 2 **C** 3 **D** 4

- 35** Which disease is spread by a vector?
- A** AIDS/HIV
 - B** cholera
 - C** malaria
 - D** measles
- 36** Which statement explains why a one-dose vaccination programme for measles has not yet eliminated the disease?
- A** Many infants under the age of eight months have passive immunity.
 - B** Some children need several booster doses to develop full immunity.
 - C** The one-dose measles vaccine has a success rate of 93%.
 - D** The virus does not often change its antibodies.
- 37** What has contributed to the increase in antibiotic resistance in bacteria?
- 1 increased use of vaccines for animal diseases
 - 2 mutations in bacterial DNA
 - 3 patients not completing their antibiotic treatment
- A** 1, 2 and 3 **B** 1 and 2 only **C** 1 and 3 only **D** 2 and 3 only
- 38** What explains why monoclonal antibodies can be used to target cancer cells?
- A** Cancer cells have different antigens from normal body cells.
 - B** Specific cancer drugs can be attached to the monoclonal antibody.
 - C** They secrete a type of antigen that binds to a specific antibody.
 - D** They are secreted by hybridomas of cancer cells and B-lymphocytes.

39 Which statements correctly describe lymphocytes?

- 1 Each B-lymphocyte has the ability to make several types of antibody molecules.
- 2 Some B-lymphocytes and T-lymphocytes become memory cells.
- 3 Plasma cells secrete antibodies into the blood plasma.
- 4 Some T-lymphocytes stimulate macrophages to kill infected cells.

- A** 1, 2, 3 and 4
B 1, 2 and 3 only
C 1 and 4 only
D 2, 3 and 4 only

40 A country introduced a measles vaccination during a measles epidemic.

Later, it was realised that vaccinated children were more likely to survive childhood than unvaccinated children, even when there were no measles epidemics.

The vaccine had given the children some protection against other pathogenic infections.

Which statement could account for this extra protection?

- A** B-lymphocytes produced memory cells which gave the children passive immunity to these infections.
- B** Memory cells produced plasma cells which secreted anti-measles antibodies that bound to antigens that closely resembled measles antigens.
- C** Memory cells produced plasma cells which secreted anti-measles antibodies that bound to any antigen.
- D** T-lymphocytes produced memory cells which gave the children natural immunity against these other infections.

BLANK PAGE

Permission to reproduce items where third-party owned material protected by copyright is included has been sought and cleared where possible. Every reasonable effort has been made by the publisher (UCLES) to trace copyright holders, but if any items requiring clearance have unwittingly been included, the publisher will be pleased to make amends at the earliest possible opportunity.

To avoid the issue of disclosure of answer-related information to candidates, all copyright acknowledgements are reproduced online in the Cambridge Assessment International Education Copyright Acknowledgements Booklet. This is produced for each series of examinations and is freely available to download at www.cambridgeinternational.org after the live examination series.

Cambridge Assessment International Education is part of the Cambridge Assessment Group. Cambridge Assessment is the brand name of the University of Cambridge Local Examinations Syndicate (UCLES), which itself is a department of the University of Cambridge.